



LED LIGHTING • LED LIGHTING • LED LIGHTING • LED LIGHTING • LED LIGHTING • LED LIGHTING

ANNOUNCING NEW LED LIGHTING OPTIONS WITH A FULL PATTERN LIGHT OUTPUT DESIGN!

Introducing a brand new line of Signal-Stat LED lamps! Equipped with standard termination & a full, multiple-diode light pattern, Signal-Stat's new line of LED Lamps is available now to easily retrofit outdated incandescent applications.

Available for various Stop, Turn & Tail, Clearance & Marker and Back-Up applications, Signal-Stat is proud to offer lamps utilizing Light Emitting Diode technology, offering them in new and exciting designs!

**More
CLEAR LENS
Versions Now
Available!**



4" ROUND LED S/T/T AND FRONT PARK & TURN LAMPS



Clear lens
Colored diodes

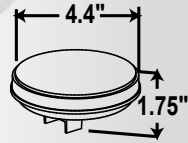

- Uses standard Right Angle PL-3 connection
- 24 diode pattern
- Unique LED array displays a full pattern light output design
- Epoxy encapsulated electronics

Part	Description
4050	Red Lamp
4050-3 ▼	Red Lamp, Bulk
4050A	Yellow Lamp
4050A-3 ▼	Yellow Lamp, Bulk
4051	Clear Lens Red Lamp
4051A	Clear Lens Yellow Lamp

6" OVAL LED S/T/T AND FRONT PARK & TURN LAMPS



Clear lens
Colored diodes

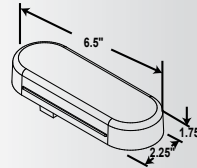

- Uses standard Right Angle PL-3 connection
- 24 diode pattern
- Unique LED array displays a full pattern light output design
- Epoxy encapsulated electronics

Part	Description
6050	Red Lamp
6050-3 ▼	Red Lamp, Bulk
6050A	Yellow Lamp
6050A-3 ▼	Yellow Lamp, Bulk
6051	Clear Lens Red Lamp
6051A	Clear Lens Yellow Lamp

NEW LED BACK-UP LAMPS

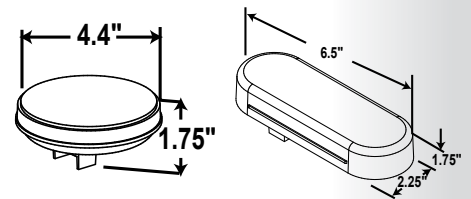

- Uses standard Right Angle PL-3 connection
- 24 diode pattern
- Unique LED array displays a full pattern light output design
- Epoxy encapsulated electronics
- Two lamps mounted horizontally or vertically required for back-up

Part	Description
4060C	Clear Back-Up
4060C-3 ▼	Clear Back-Up, Bulk
6060C	Clear Back-Up
6060C-3 ▼	Clear Back-Up, Bulk

2 1/2" ROUND LED C/M LAMPS



Clear lens
Colored diodes

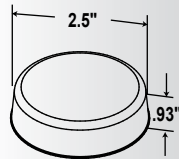

- Standard PL-10 connection
- Unique 13 diode starburst light output
- Not suitable for PC requirements

Part	Description
1050	Red Lamp
1050-3 ▼	Red Lamp, Bulk
1050A	Yellow Lamp
1050A-3 ▼	Yellow Lamp, Bulk
1051	Clear Lens Red Lamp
1051A	Clear Lens Yellow Lamp

2 1/2" ROUND LED C/M LAMPS W/REFLEX LENS

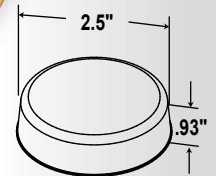

- Standard PL-10 connection
- 4 diode light output
- Not suitable for PC requirements

Part	Description
1052	Red Lamp
1052-3	Red Lamp, Bulk
1052A	Yellow Lamp
1052A-3	Yellow Lamp, Bulk

2" ROUND LED C/M LAMPS

Clear lens
Colored diodes



- Standard PL-10 connection
- Unique 10 diode starburst light output
- Not suitable for PC requirements

Part	Description
3050	Red Lamp
3050-3 ▼	Red Lamp, Bulk
3050A	Yellow Lamp
3050A-3 ▼	Yellow Lamp, Bulk
3051	Clear Lens Red Lamp
3051-3 ▼	Clear Lens Red Lamp, Bulk
3051A	Clear Lens Yellow Lamp
3051A-3 ▼	Clear Lens Yellow Lamp, Bulk

TRIANGULAR LED BUS LAMPS

NEW

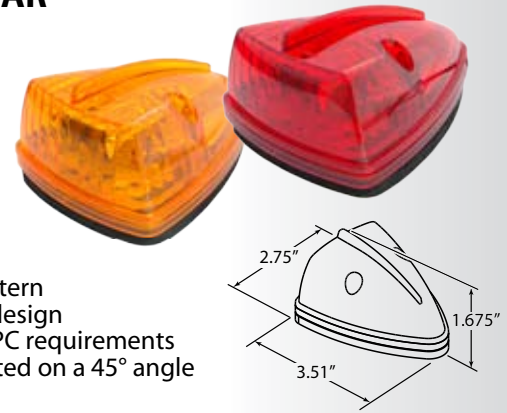

- 13 Diode Pattern
- Hard-wired design
- Suitable for PC requirements when mounted on a 45° angle

Part	Description
1155	Red Lamp
1155-3 ▼	Red Lamp, Bulk
1155A	Yellow Lamp
1155A-3 ▼	Yellow Lamp, Bulk

15 SERIES LED C/M LAMPS



- Standard PL-10 connection
- 2 diode (red), 3 diode (yellow) LED pattern
- Not suitable for PC requirements

Part	Description
1560	Red Lamp
1560-3 ▼	Red Lamp, Bulk
1560A	Yellow Lamp
1560A-3 ▼	Yellow Lamp, Bulk

19 SERIES LED C/M LAMPS



- Standard PL-10 connection
- 4 diode LED pattern
- Not suitable for PC requirements

Part	Description
1960	Red Lamp
1960-3 ▼	Red Lamp, Bulk
1960A	Yellow Lamp
1960A-3 ▼	Yellow Lamp, Bulk

21 SERIES LED C/M LAMPS



- Acrylic lens
- 8 diode pattern
- Less susceptible to shock and vibration

Part	Description
2150	Red Lamp
2150-3 ▼	Red Lamp, Bulk
2150A	Yellow Lamp
2150A-3 ▼	Yellow Lamp, Bulk

RECTANGULAR LED DOUBLE BULLSEYE LAMPS



- Hard-wired design
- Encapsulated electronics
- 16 diode double bullseye LED pattern

Part	Description
2660	Red Lamp
2660-3 ▼	Red Lamp, Bulk
2660A	Yellow Lamp
2660A-3 ▼	Yellow Lamp, Bulk

2 1/2" ROUND LED BEEHIVE C/M LAMPS

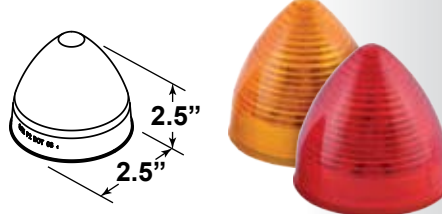

- Popular replacement for cab marker or corner trailer applications
- 13 diode pattern
- Polycarbonate lens and housing
- Standard PL-10 connection

Part	Description
1075	Red Lamp
1075-3 ▼	Red Lamp, Bulk
1075A	Yellow Lamp
1075A-3 ▼	Yellow Lamp, Bulk

2" ROUND LED BEEHIVE C/M LAMPS

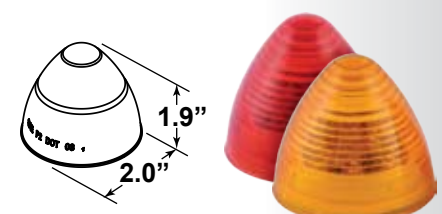

- Popular replacement for cab marker or corner trailer applications
- 10 diode pattern
- Polycarbonate lens and housing
- Standard PL-10 connection

Part	Description
3075	Red Lamp
3075-3 ▼	Red Lamp, Bulk
3075A	Yellow Lamp
3075A-3 ▼	Yellow Lamp, Bulk

SINGLE FACE LED PEDESTAL LAMPS

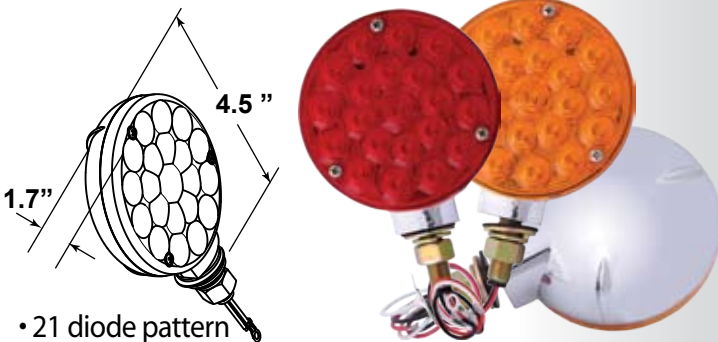

- 21 diode pattern
- Polycarbonate lens
- Chrome plated housing

Part	Description
2751	Red Lamp
2751-3 ▼	Red Lamp, Bulk
2751A	Yellow Lamp
2751A-3 ▼	Yellow Lamp, Bulk

DOUBLE FACE LED PEDESTAL LAMPS

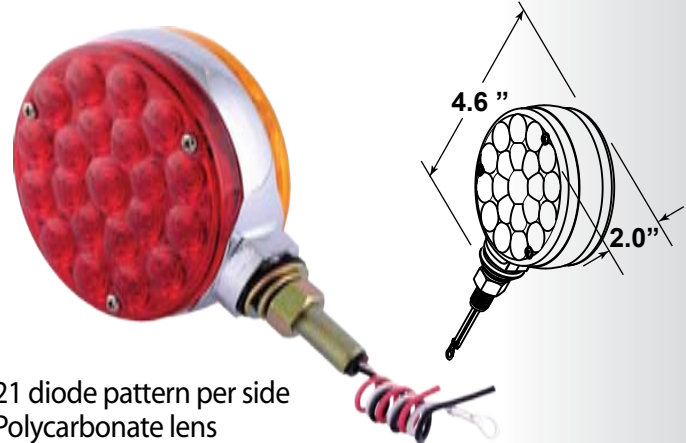

- 21 diode pattern per side
- Polycarbonate lens
- Chrome plated housing

Part	Description
2750	Double Faced Lamp
2750-3 ▼	Double Faced Lamp, Bulk

RECTANGULAR LED S/T/T LAMPS

- Uses standard Right Angle PL-3 connection
- 24 diode pattern
- Unique LED array displays a full pattern light output design
- Epoxy encapsulated electronics



Part	Description
4550	Red Lamp
4550-3 ▼	Red Lamp, Bulk
4550A	Yellow Lamp
4550A-3 ▼	Yellow Lamp, Bulk



Truck-Lite extends a Limited 2-Year Warranty to the original purchaser that the Signal-Stat Sealed LED lamp is free from defects in workmanship and/or materials only. Truck-Lite will replace any Sealed LED Lamp to the original consumer/purchaser, if the lamp fails due to

defects in workmanship and/or materials only. The LED Limited 2-Year Warranty does not apply to severe applications such as buses, construction equipment and off-road vehicles. These applications are example only and are not all inclusive of each excluded application. Many chemicals and/or cleaners are incompatible with Signal-Stat sealed LED products. The LED 2-Year Warranty does not apply to damage associated with incompatible chemicals or cleaners. Not subject to improper installation or modification and must be used only with Truck-Lite approved wiring accessories. Any violation of these conditions will void this LED 2-Year Lamp Warranty.

This LED 2-Year Lamp Warranty is not transferable and applies to the original installation of the Signal-Stat Sealed LED lamp for as long as the original consumer/purchaser owns the vehicle.

CORPORATE HEADQUARTERS
 310 E. Elmwood Ave., Falconer, NY 14733
 Website: www.truck-lite.com
 Phone: 800/888-7095 or 716/665-6214
 Fax: 716/665-6403

CUSTOMER SERVICE:
 E-mail: customerservice@truck-lite.com
 Phone: 800/562-5012 or 716/661-1162
 Fax: 800/685-6412 or 716/665-4825

TECHNICAL SUPPORT
 E-mail: tltech@truck-lite.com
 Phone: 888/562-5012